

Article number: 2310309463ESD

Description: E+G Antistatic base for levelling elements  
LV.A-100-14-AS-M10x68-ESD-C

## Measures

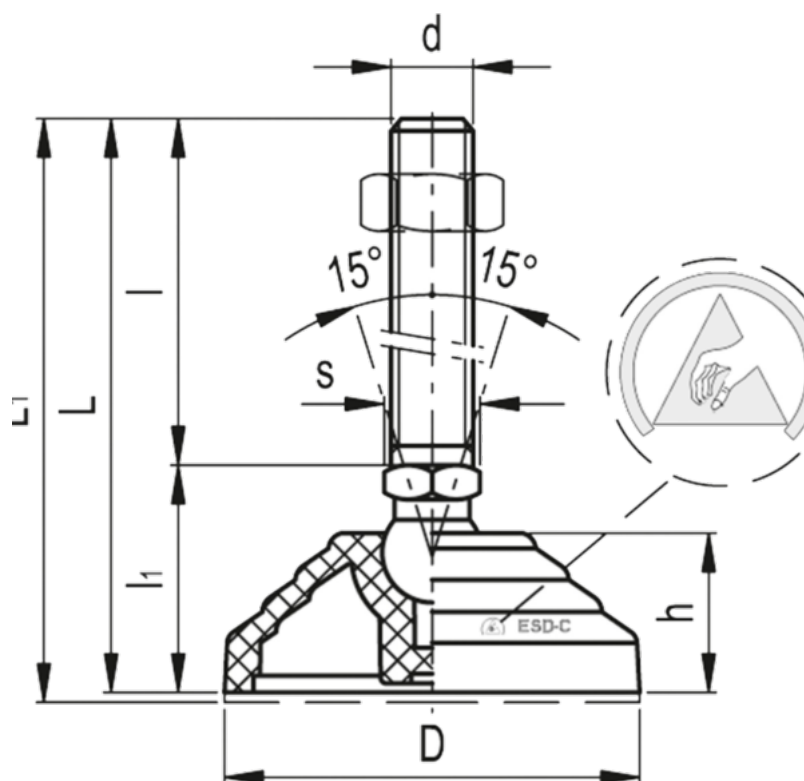

Articulation	= 14	Max load	= 18000
D	= 100	s	= 14
d	= M10	Weight in (g)	= 167
h	= 24		
l	= 68		
l1	= 33		
L	= 101		
L1	= 104		